

General Specifications

Model UM351 Digital Indicator with Alarms with Active Color PV Display



GS 05F01D12-01E

General

Model UM351 Digital Indicator with Alarms is a precision alarm instrument provided with universal input. For excellent monitoring operability, it has a large PV display with the PV display color changing function "Active Color PV Display." It is provided with four alarm setting points or setting outputs (one is optional function). A retransmission output and 15 V DC loop power supply are also provided as standard. A communication function and 24 V DC loop power supply are available optionally.

Main Features

- Extra-large digital display allows the indicated values to be read even from a long distance. LEDs of 20mm height are used for the PV display.
- The PV display color changing function "Active Color PV Display" is provided. PV display color is changed from green to red and vice versa when an alarm occurs. The color also can be fixed in green or red.
- Universal input allows simple setting of the input type (thermocouple, RTD or mV) or PV input range from the front panel.
- Various communication functions are provided. Communication is possible with personal computer, programmable logic controller, and other instruments.

Function Block Diagram

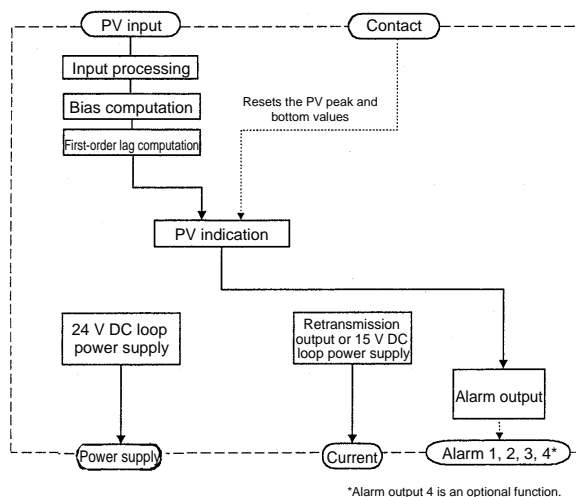

Functional Specifications

Signal Computation Function

Measured input computation:
Bias addition (-100.0 to 100.0% of PV input range span), first-order lag filter (time constant off, 1 to 120 s)

UM351



Indication in green or red color

UM351E
"E" indicates the model with expanded functions.

Contact input: Retains and displays peak and bottom values of PV input values. Resets the peak and bottom values.

Alarm Function

Six types of alarm functions are provided. The alarm status is indicated by the alarm lamp on the front panel. Also, four points among them (one is optional function) can be output as relay contact outputs.

Alarm types:

PV high limit, PV low limit, De-energized on PV high limit, De-energized on PV low limit, Fault diagnosis, and FAIL output

Alarm setting ranges:

PV alarms: -100.0 to 100.0% of PV input range
Alarm hysteresis: 0.0 to 100.0% of PV input range span

Delay timer:

0.00 to 99.99 (minute, second)
An alarm is output when the delay timer expires after the alarm setpoint is reached. Setting for each alarm is possible.

Stand-by action:

Stand-by action can be set to make PV alarm OFF during start-up.

Fault diagnosis alarm:

Input burnout, A/D conversion error or thermocouple RJC error

FAIL output: Abnormality in software or hardware

Display and Operation Functions

PV display: 4-digit digital display for engineering data

Parameter display:

4-digit digital display for various data, including parameters

Status indication: Alarm indicator lamp

4 lamps; AL1, AL2, AL3 and AL4

PV display color changing function “Active Color PV Display” :
 (Factory-set default : Fixed in red mode)
 This function automatically changes PV display color by the action described below.
 Green-to-red or red-to-green changing action is selectable.

Link to alarm 1 mode :
 Alarm OFF : green, Alarm ON : red
 Setting of Alarm OFF : red, Alarm ON : green is possible.

Link to alarms 1 and 2 mode:
 Alarm OFF : green, Alarm ON : red
 Setting of Alarm OFF : red, Alarm ON : green is possible.

PV limit mode :
 Within the preset PV range : green,
 Out of the preset PV range : red
 Setting of Within the preset PV range : red,
 Out of the preset PV range : green is possible.
 The range (high limit and low limit) is changeable using a parameter.

Fixed color mode :
 PV display color is fixed in green or red.

Operation keys:
 △ and ▽ keys: Increase or decrease setpoints or various parameters.
 SET/ENT key: Sets setpoint data, calls or selects various parameters.

SELECT display:
 Allows selection and registration of frequently changed parameters from the operating parameters during operation.
 For example, if the alarm-1 setpoint is registered in the SELECT display, the setpoint can easily be displayed during operation.

Security function:
 Operation can be key-locked by setting a parameter.
 Operation can be inhibited by a password.

● **Communication Functions (Optional Function)**

The communication function, provided with the instrument, allows connection to a personal computer, and programmable logic controller.

- Communication protocol
 - Computer link communication:
 - Communication protocol with a personal computer.
 - Ladder communication:
 - Communication protocol with programmable logic controller
 - MODBUS communication:
 - Communication protocol with a personal computer, or PLC.
- Communication interface
 - Communication protocol:
 - Computer link or ladder communication
 - Standards: EIA RS-485
 - Maximum number of connectable controllers: 31 GREEN series controllers
 - Maximum communication distance: 1,200 m
 - Communication method:
 - Two-wire half duplex, or four-wire half duplex, start-stop synchronization system, non-procedural
 - Communication rate:
 - 600, 1200, 2400, 4800, or 9600 bps

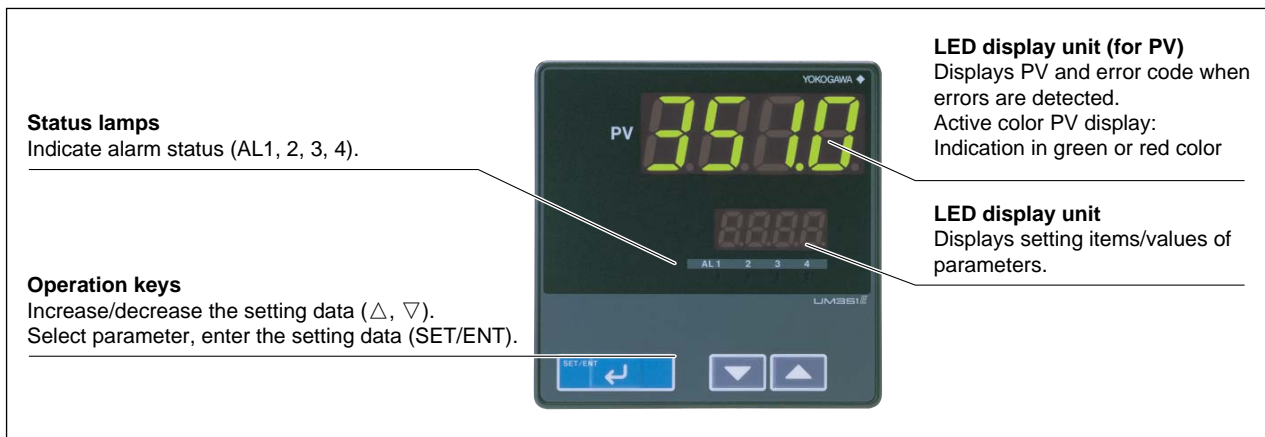

Sample Structures of Communication Systems Configuration Diagram

(1) Computer link communication/MODBUS communication

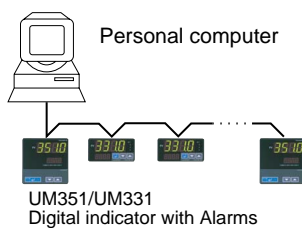

(2) Ladder communication

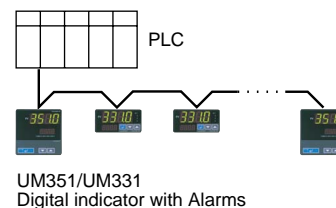

■ Hardware Specifications

PV Input Signal

Number of input points: 1

Input system: The type of input and instrument range can be specified using the input range code shown in the table below with key operation or via communication.

Sampling period: 250 ms

Input type, instrument range and measurement accuracy: Refer to the table below.

Burnout detection:

Functions at thermocouple (TC), RTD or standard signal of 0.4 to 2 V or 1 to 5V.
Upscale, downscale, and off can be specified.
For standard signal, set to burnout at 0.1 V or less.

Input bias current: 0.05 μ A for TC and RTD b-terminal

Measurement current (RTD): About 0.13 mA

Input resistance: 1 M Ω or more for TC or mV input

About 1 M Ω for DC voltage input

Allowable signal source resistance:

250 Ω or less for TC or mV input

Effects of signal source resistance:

0.1 μ V/ Ω or less

2 k Ω or less for DC voltage input

Effects of signal source resistance:

About 0.01%/100 Ω

Allowable wiring resistance:

Maximum 150 Ω /wire (resistance in each of

three wires must be equal) for RTD input

However, maximum 10 Ω /wire for the range of -150.0 to 150.0 $^{\circ}$ C,

Wiring resistance effect: \pm 0.1 $^{\circ}$ C/10 Ω

Allowable input voltage:

\pm 10 V DC for TC, mV or RTD input

\pm 20V DC for DC voltage input

Noise rejection ratio:

Normal mode 40dB (50/60Hz) or more

Common mode 120dB (50/60Hz) or more

Reference junction compensation error:

\pm 1.0 $^{\circ}$ C (15 to 35 $^{\circ}$ C),

\pm 1.5 $^{\circ}$ C (0 to 15 $^{\circ}$ C, 35 to 50 $^{\circ}$ C)

Applicable standards: JIS, IEC, DIN (ITS-90) for TC and RTD

Response time: 2 second or less, 63% (10 - 90%)

(The time required for transmission output to reach 63% of the maximum excursion when PV abruptly changes from 10% to 90%)

Input type	Input range code	Instrument range ($^{\circ}$ C)	Instrument range ($^{\circ}$ F)	Measurement accuracy*1		
Unspecified(when shipped from the factory)	OFF	Set the data item PV input Type"IN" to the OFF option to leave the PV input type undefined.				
Thermocouple	K	1	-200 to 1370 $^{\circ}$ C	-300 to 2500 $^{\circ}$ F	\pm 0.1% of instrument range \pm 1 digit for temperatures equal to or higher than 0 $^{\circ}$ C, \pm 0.2% of instrument range \pm 1 digit for temperatures below 0 $^{\circ}$ C	
		2	-199.9 to 999.9 $^{\circ}$ C	0 to 2300 $^{\circ}$ F		
		3	-199.9 to 500.0 $^{\circ}$ C	-199.9 to 999.9 $^{\circ}$ F		
	J	4	-199.9 to 999.9 $^{\circ}$ C	-300 to 2300 $^{\circ}$ F		
		5	-199.9 to 400.0 $^{\circ}$ C	-300 to 750 $^{\circ}$ F		
	T	6	0.0 to 400.0 $^{\circ}$ C	-199.9 to 750.0 $^{\circ}$ F		
		7	0 to 1800 $^{\circ}$ C	32 to 3300 $^{\circ}$ F		\pm 0.15% of instrument range \pm 1 digit for temperatures equal to or higher than 400 $^{\circ}$ C \pm 5% of instrument range \pm 1 digit for temperatures below 400 $^{\circ}$ C
	S	8	0 to 1700 $^{\circ}$ C	32 to 3100 $^{\circ}$ F		\pm 0.15% of instrument range \pm 1 digit
	R	9	0 to 1700 $^{\circ}$ C	32 to 3100 $^{\circ}$ F		
	N	10	-200 to 1300 $^{\circ}$ C	-300 to 2400 $^{\circ}$ F		\pm 0.1% of instrument range \pm 1 digit \pm 0.25% of instrument range \pm 1 digit for temperature below 0 $^{\circ}$ C
	E	11	-199.9 to 999.9 $^{\circ}$ C	-300 to 1800 $^{\circ}$ F		\pm 0.1% of instrument range \pm 1 digit for temperatures equal to or higher than 0 $^{\circ}$ C
	L (DIN)	12	-199.9 to 900.0 $^{\circ}$ C	-300 to 1300 $^{\circ}$ F		
	U (DIN)	13	-199.9 to 400.0 $^{\circ}$ C	-300 to 750 $^{\circ}$ F		\pm 0.2% of instrument range \pm 1 digit for temperatures below 0 $^{\circ}$ C
		14	0.0 to 400.0 $^{\circ}$ C	-199.9 to 750.0 $^{\circ}$ F		
W (DIN)	15	0 to 2300 $^{\circ}$ C	32 to 4200 $^{\circ}$ F	\pm 0.2% of instrument range \pm 1 digit		
Platine1 2	16	0 to 1390 $^{\circ}$ C	32 to 2500 $^{\circ}$ F	\pm 0.1% of instrument range \pm 1 digit		
PR20-40	17	0 to 1900 $^{\circ}$ C	32 to 3400 $^{\circ}$ F	\pm 0.5% of instrument range \pm 1 digit for temperatures equal to or higher than 800 $^{\circ}$ C No guarantee of accuracy for temperatures below 800 $^{\circ}$ C		
RTD	JPt100	18	0 to 2000 $^{\circ}$ C	32 to 3600 $^{\circ}$ F	\pm 0.2% of instrument range \pm 1 digit	
		30	-199.9 to 500.0 $^{\circ}$ C	-199.9 to 999.9 $^{\circ}$ F	\pm 0.1% of instrument range \pm 1 digit (Note 1) (Note 2)	
	31	-150.0 to 150.0 $^{\circ}$ C	-199.9 to 300.0 $^{\circ}$ F	\pm 0.2% of instrument range \pm 1 digit (Note 1)		
	Pt100	35	-199.9 to 850.0 $^{\circ}$ C	-300 to 1560 $^{\circ}$ F	\pm 0.1% of instrument range \pm 1 digit (Note 1) (Note 2)	
		36	-199.9 to 500.0 $^{\circ}$ C	-199.9 to 999.9 $^{\circ}$ F	\pm 0.2% of instrument range \pm 1 digit (Note 1)	
37	-150.0 to 150.0 $^{\circ}$ C	-199.9 to 300.0 $^{\circ}$ F	\pm 0.2% of instrument range \pm 1 digit (Note 1)			
Standard signal	0.4 to 2 V	40	0.400 to 2.000	Scaling is enable in the following 4 range.	\pm 0.1% of instrument range \pm 1 digit The read-out range can be scaled between -1999 and 9999.	
	1 to 5 V	41	1.000 to 5.000			
DC voltage	0 to 2 V	50	0.000 to 2.000	-1999 to 9999		
	0 to 10 V	51	0.00 to 10.00	-199.9 to 999.9		
	-10 to 20 mV	55	-10.00 to 20.00	-19.99 to 99.99		
	0 to 100 mV	56	0.0 to 100.0	-1.999 to 9.999		

*1: Performance in the standard operating condition (at 23 $^{\circ}$ C \pm 2 $^{\circ}$ C, 55 \pm 10%RH, and 50/60Hz power frequency)

Note 1: The accuracy is \pm 0.3 $^{\circ}$ C of instrument range \pm 1 digit for a temperature range from 0 to 100 $^{\circ}$ C.

Note 2: The accuracy is \pm 0.5 $^{\circ}$ C of instrument range \pm 1 digit for a temperature range from -100 to 0 $^{\circ}$ C and 100 to 200 $^{\circ}$ C.

24 V DC Loop Power Supply for Sensor

Supplies power to a two-wire transmitter.
A resistor (10 to 250 Ω) connected between the indicator and transmitter converts a current signal into a voltage signal, which is then read via the PV input terminal.

Supply voltage: 21.6 to 28.0 V DC
Maximum supply current: About 30 mA (only for models with 24 V DC loop power supply)

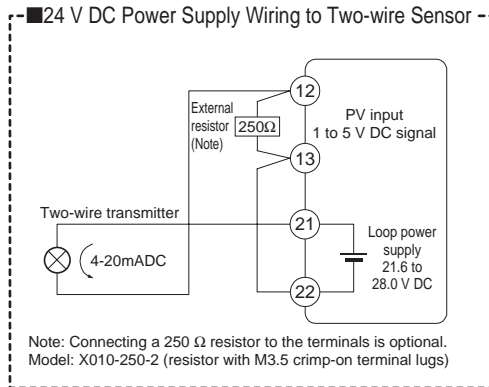

Retransmission Output

PV is output. Can also be used for 15 V DC loop power supply.

Number of output points: 1
Output signal: 4 to 20 mA DC
Load resistance: 600 Ω or less
Output accuracy: ±0.3% of span
Performance in the standard operating conditions (at 23±2°C, 55±10% RH, and 50/60 Hz power frequency)

When used for 15 V DC loop power supply:
Supply voltage: 14.5 to 18.0 V DC
Maximum supply current: About 21 mA (with a protection circuit for a field short circuit)

Contact Input

Usage: Resets the displayed PV peak and bottom values.
Number of input points: 1
Input type: Non-voltage contact input or transistor open collector input
Input contact rating: 12 V DC, 10 mA or more
On/off detection:
For non-voltage contact input,
ON = contact resistance of 1 kΩ or less,
OFF = contact resistance of 20 kΩ or more.
For transistor open collector input,
ON = 2 V or less,
OFF = leak current of 100 μA or less.
Minimum status detection hold time: About 1 s

Contact Outputs

Usage: Alarm output, FAIL output
Number of relay contact output points: 4 (Alarm-4 is optional function.)
Alarm-1 to -3 relay contact rating: 240 V AC 1 A, or 30 V DC 1 A
a-contact (COM terminals are common for every contact output.) (b-contact for FAIL output)
Alarm-4 relay contact rating: 250 V AC 3 A, or 30 V DC 3 A (resistance load)
3 terminals (NC, NO and Common), transfer contact

● Display Unit Specifications

PV display unit:
4-digit 7-segment green/red LED, each digit 20 mm in height
Parameter display unit:
4-digit 7-segment red LED, each digit 9.3 mm in height
Status indicator lamps: LEDs

● Safety and EMC Standards

Safety: Compliant with IEC/EN61010-1: 2001, approved by CSA1010, approved by UL508.
Installation category : CAT. II (IEC/EN61010, CSA1010) Pollution degree : 2 (IEC/EN61010, CSA1010)
Measurement category : I (CAT. I : IEC/EN61010)
Rated measurement input voltage : 10V DC max.(across terminals), 300V AC max.(across ground)
Rated transient overvoltage : 1500V (Note)
Note : It is a value on the safety standard which is assumed by IEC/EN61010-1 in measurement category I, and is not the value which guarantees an apparatus performance.

EMC standards: Complies with EN61326
During test, the controller continues to operate with the measurement accuracy within ±20% of the range.

● Construction, Mounting, and Wiring

Construction: Dust-proof and Drip-proof front panel conforming to IP55.
Material: ABS resin and polycarbonate
Case color: Black
Weight: About 1 kg or less
External dimensions: 96(W)×48(H)×100 (depth from the panel face) (mm)
Mounting: Panel-mounting type. With right and left mounting hardware (1 each)
Side-by-side close mounting is not permitted.
Panel cutout dimensions: 92^{+0.8}₀(W)×45^{+0.6}₀(H) (mm)
Mounting attitude: Up to 30 degrees upward facing. No downward tilting allowed.
Wiring: M3.5 (ISO 3.5 mm) screw terminals (for signal wiring, power/grounding wiring as well)

● Power Supply and Isolation Specifications

Power Supply Specifications

Power supply: Voltage rating at 100 to 240 V AC ($\pm 10\%$),
50/60 Hz

Power consumption: Max. 20 VA (Max. 8.0 W)

Internal fuse rating: 250 V AC, 1.6 A time-lag fuse

Data backup: Non-volatile memory (service life about
100,000 times of writings)

Withstanding voltage:

1500 V AC for 1 minute between primary and
secondary terminals

1500 V AC for 1 minute between primary and
grounding terminals

1500V AC for 1 minute between grounding
and secondary terminals

500V AC for 1 minute between two secondary
terminals

(Primary terminals: Power supply and relay output terminals
	Secondary terminals: Analog input/output signal terminals, and contact input terminals

Isolation resistance:

Between power supply terminal and ground-
ing terminals, 500 V DC 20 M Ω or more

Grounding: Class D grounding (Class 3 grounding)
(grounding resistance of 100 Ω or less)

Isolation Specifications

PV input terminals:

Isolated from other input/output terminals.
Not isolated from the internal circuit.

24 V DC loop power supply terminals for sensor:

Isolated from other input/output terminals
and internal circuit.

Retransmission output terminals:

Isolated from other input/output terminals
and internal circuit.

Contact input terminals:

Not isolated from communication terminals.
Isolated from other input/output terminals
and internal circuit.

Relay contact output terminals:

Isolated from other input/output terminals
and internal circuit.

RS-485 communication terminals:

Not isolated from contact input terminals.
Isolated from other input/output terminals
and internal circuit.

Power supply terminals:

Isolated from other input/output terminals,
and internal circuit.

Grounding terminals:

Isolated from other input/output terminals,
and internal circuit.

● Environmental Conditions

Normal operating conditions:

Ambient temperature: 0 to 50°C

0 to 40°C when using 24 V DC loop power
supply for sensor

Temperature change rate: 10°C/h or less

Ambient humidity: 20 to 90% RH (nocondensation)

Magnetic field: 400 A/m or less

Continuous vibration at 5 to 14 Hz:

Peak-to peak amplitude of 1.2 mm or less

Continuous vibration at 14 to 150 Hz:

4.9 m/s² or less

Short-period vibration: 14.7 m/s², 15 s or less

Shock: 147 m/s² or less, 11 ms

Installation altitude:

2,000 m or less above sea level

Warm-up time: 30 minutes or more after power on

Transportation and storage conditions:

Temperature: -25 to 70°C

Temperature change rate: 20°C/h or less

Humidity: 5 to 95% RH (no condensation)

Effects of operating conditions

Effect of ambient temperature:

For voltage and TC inputs:

$\pm 1 \mu\text{V}/^\circ\text{C}$ or $\pm 0.01\%$ of F.S./°C, which-
ever is greater,

For RTD input:

$\pm 0.05 \text{ }^\circ\text{C}/^\circ\text{C}$ (ambient temperature) or less

For analog output:

$\pm 0.05\%$ of F.S./°C or less

Effects of operating conditions

Effect of ambient temperature:

For voltage or TC input:

Equal or less than whichever is greater,
 $\pm 1 \mu\text{V}/^\circ\text{C}$ or $\pm 0.01\%$ of F.S./°C.

For RTD input:

$\pm 0.05 \text{ }^\circ\text{C}/^\circ\text{C}$ (ambient temperature) or less

For analog output:

$\pm 0.05\%$ of F.S./°C or less

Effect of power supply fluctuation (within rated voltage):

For analog input:

Equal or less than whichever is greater,
 $\pm 1 \mu\text{V}/10 \text{ V}$ or $\pm 0.01\%$ of F.S./10 V.

For analog output:

$\pm 0.05\%$ of F.S./10 V or less

Terminal Arrangements for Standard Type

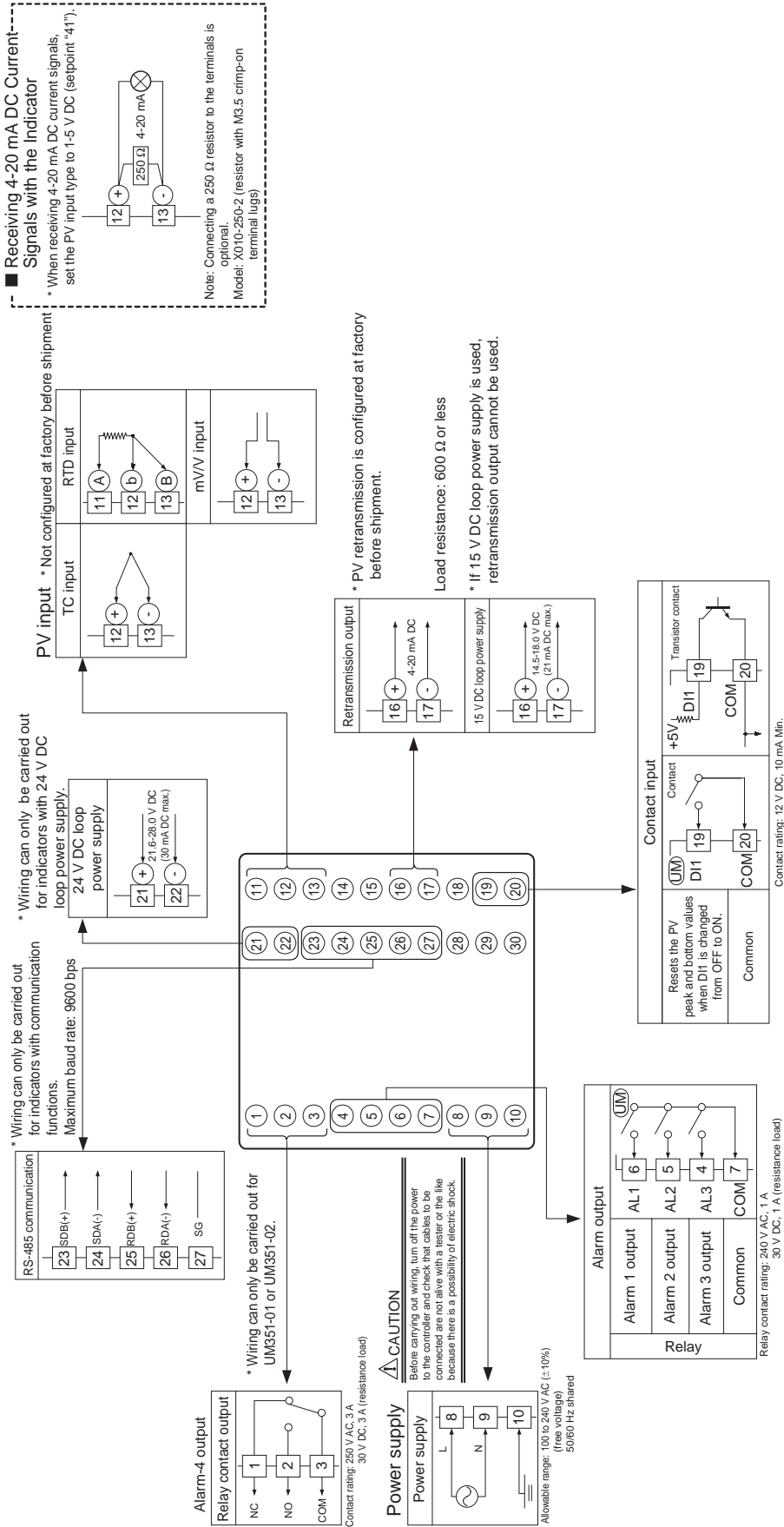

External Dimensions and Panel Cutout Dimensions

Unit: mm

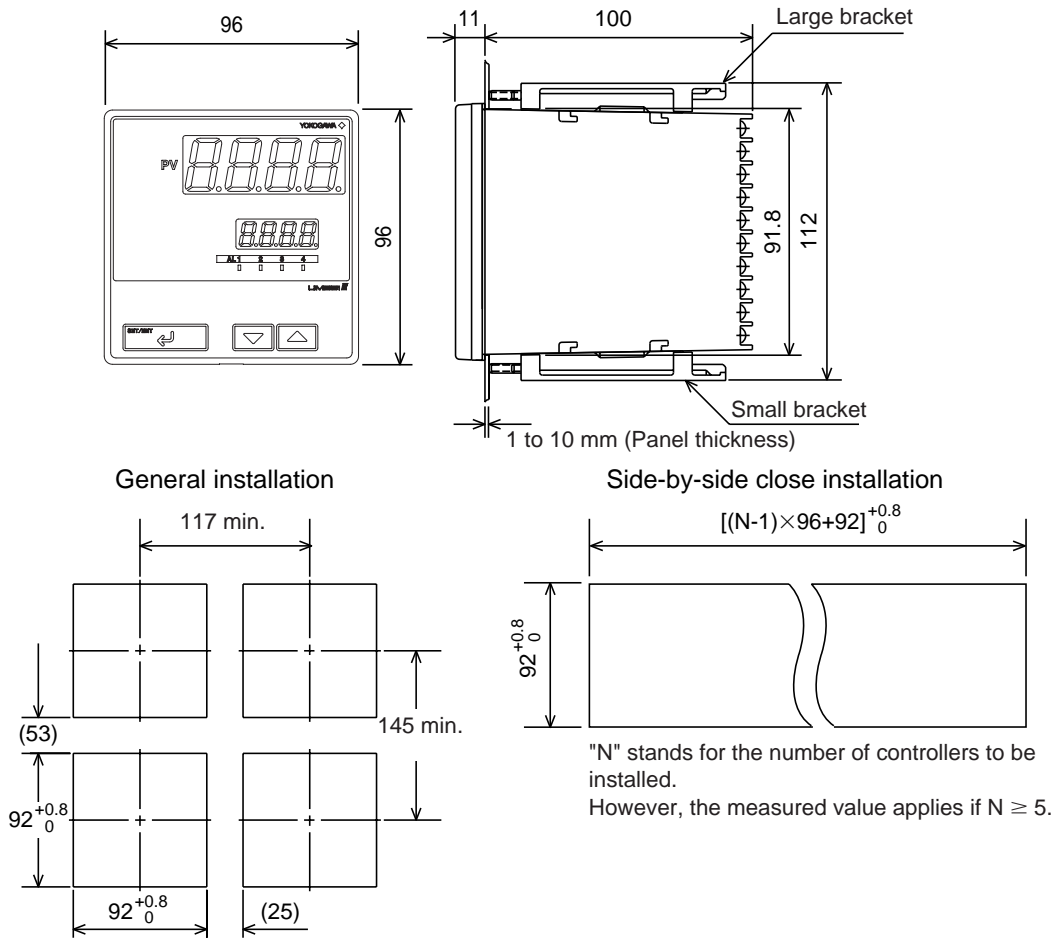

Normal Allowable Deviation= \pm (Value of JIS B 0401-1999 tolerance grade IT18) /2

Model and Suffix Codes

Model	Suffix Code	Description
UM351		Digital indicator with alarms (provided with retransmission output and 15 V DC loop power supply as standard)
Type	-0 -3	Standard type with three alarms Standard type with three alarms (with 24 V DC loop power supply)
Optional functions	0 1 2	None With communication and additional alarm-4 With additional alarm-4

Standard accessories: Brackets (mounting hardware), unit label, and User's Manuals.

Terminal cover (optional part) is provided.

Items to be Specified when Ordering

Model and suffix code, necessary/unnecessary of User's Manual or QIC.